

A TUNER CIRCUIT For [E,EB] areas. (P.C.Board: on page 42)

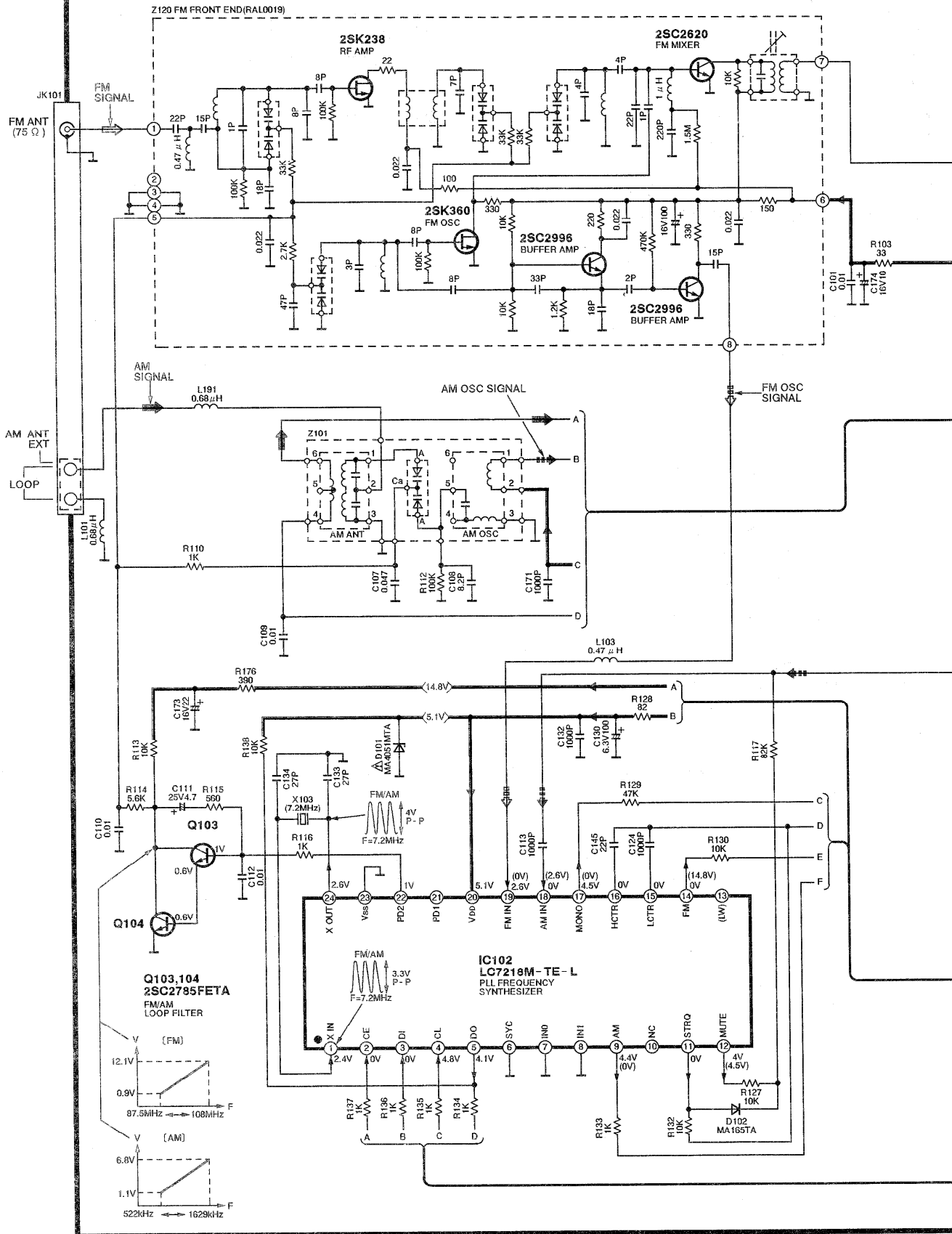

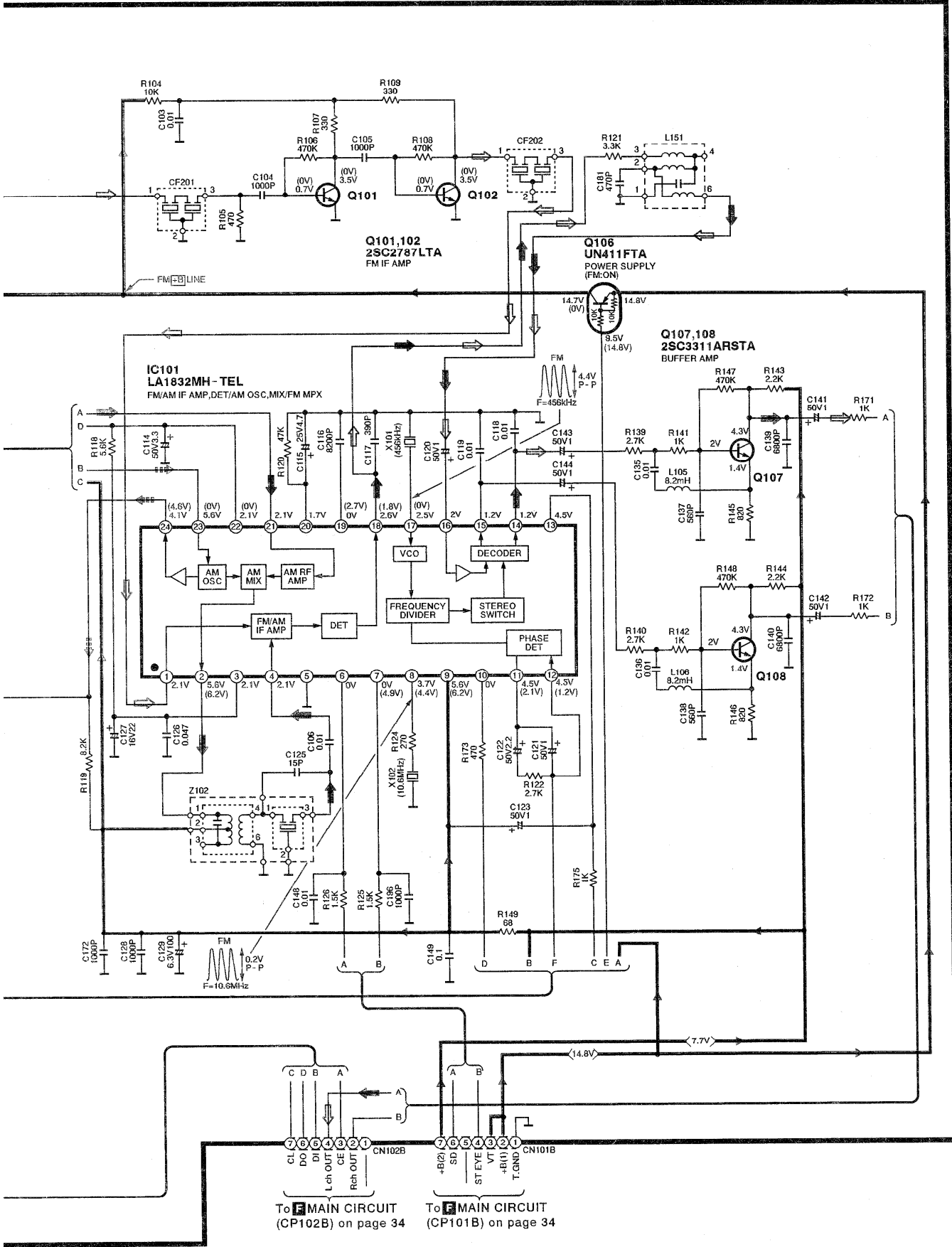

A TUNER CIRCUIT For [EG,EP] areas. (P.C.Board: on page 42)

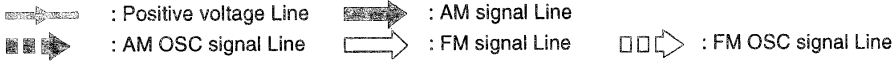
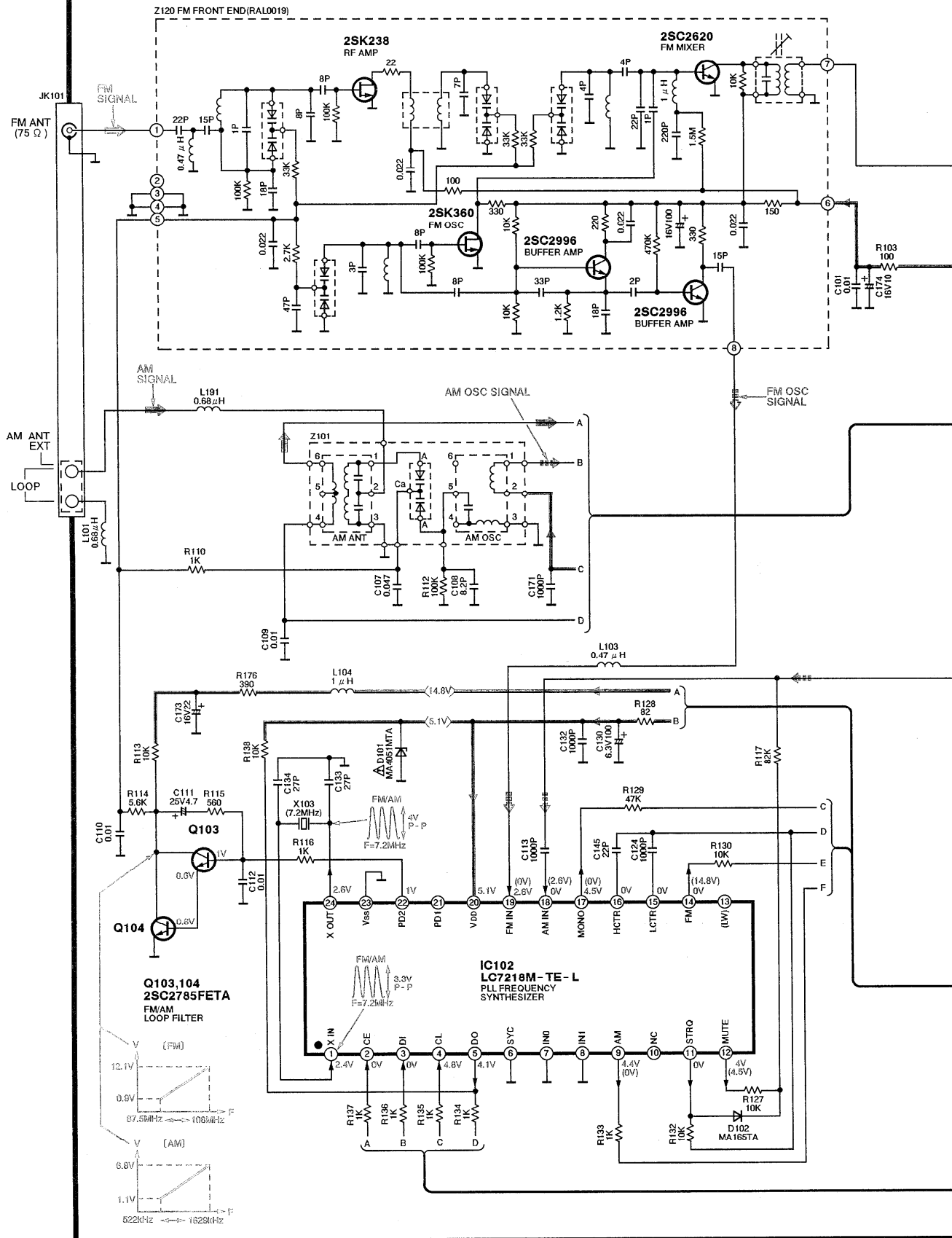

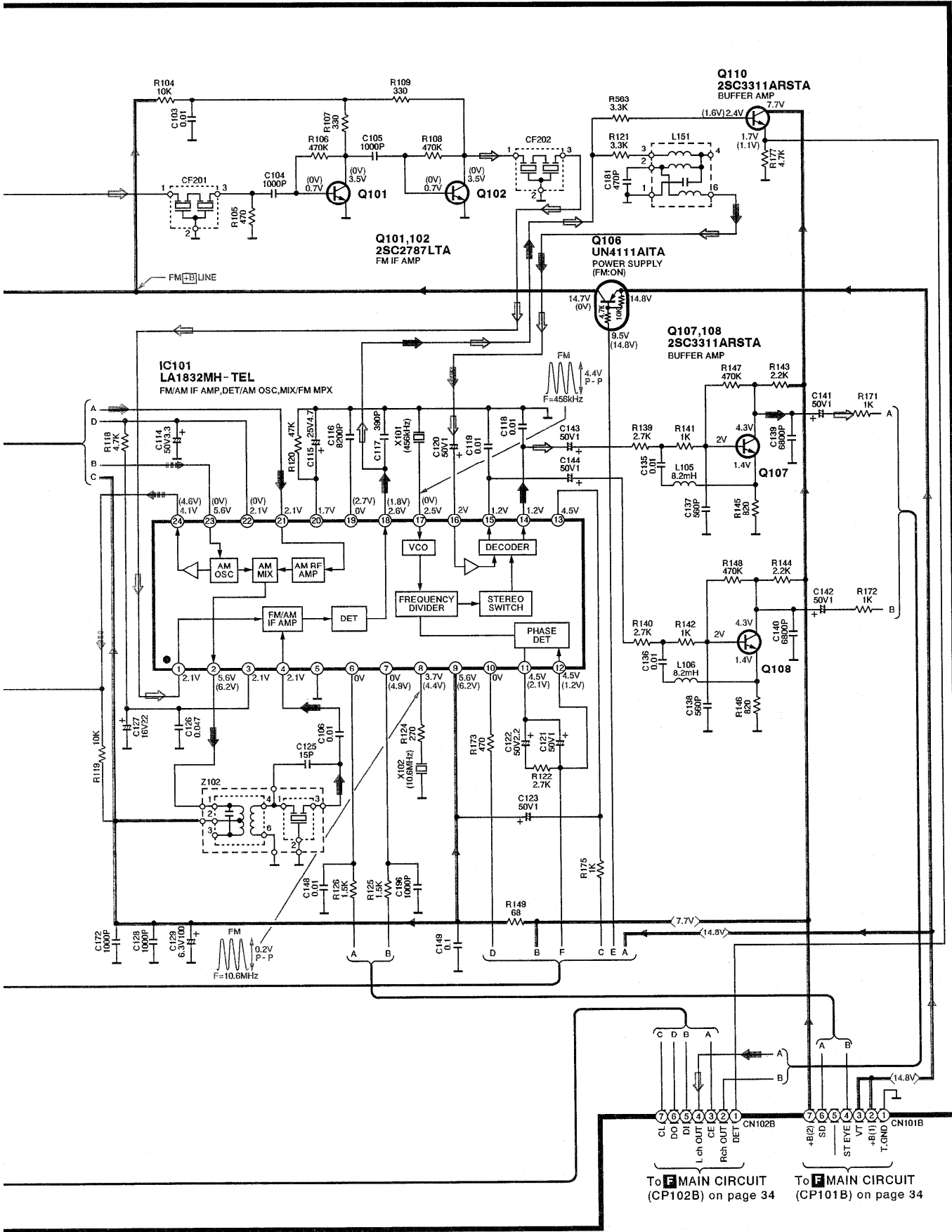
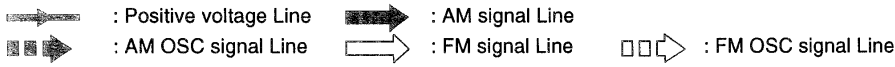

A TUNER CIRCUIT For [GC,GN] areas. (P.C.Board on page 43)

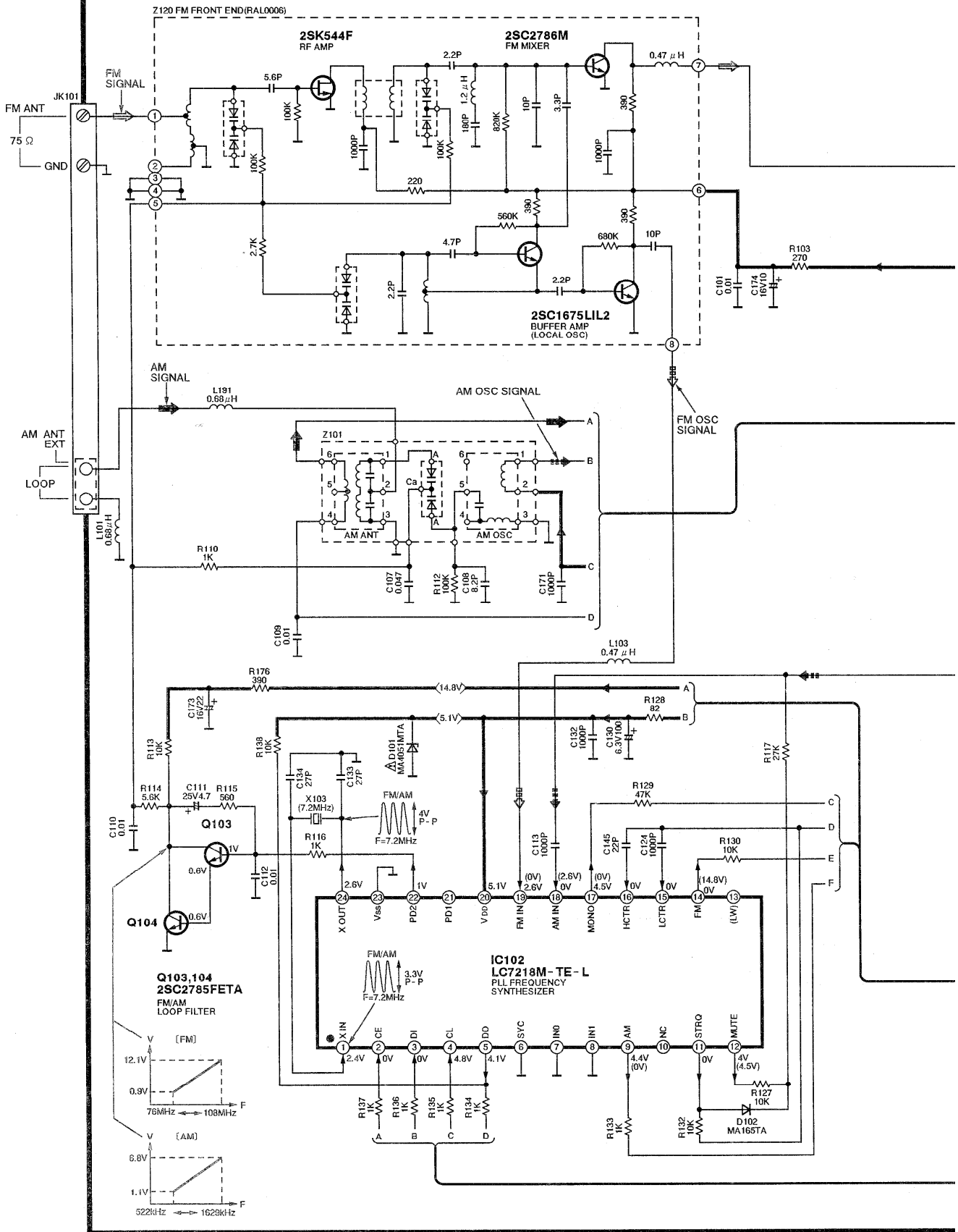

- : Positive voltage Line
- : AM signal Line
- : AM OSC signal Line
- : FM signal Line
- : FM OSC signal Line

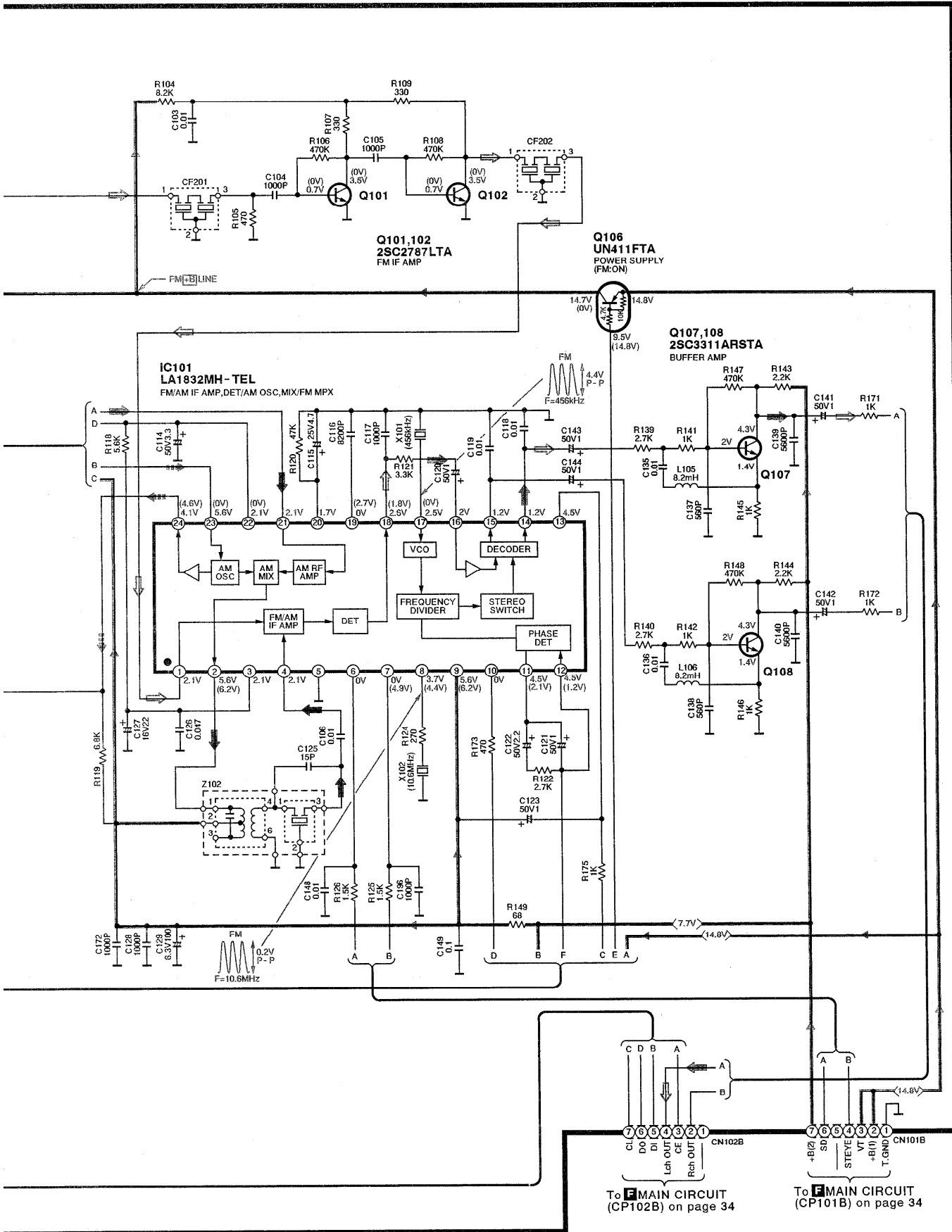

B OPERATION CIRCUIT (P.C.Board: on page 43)

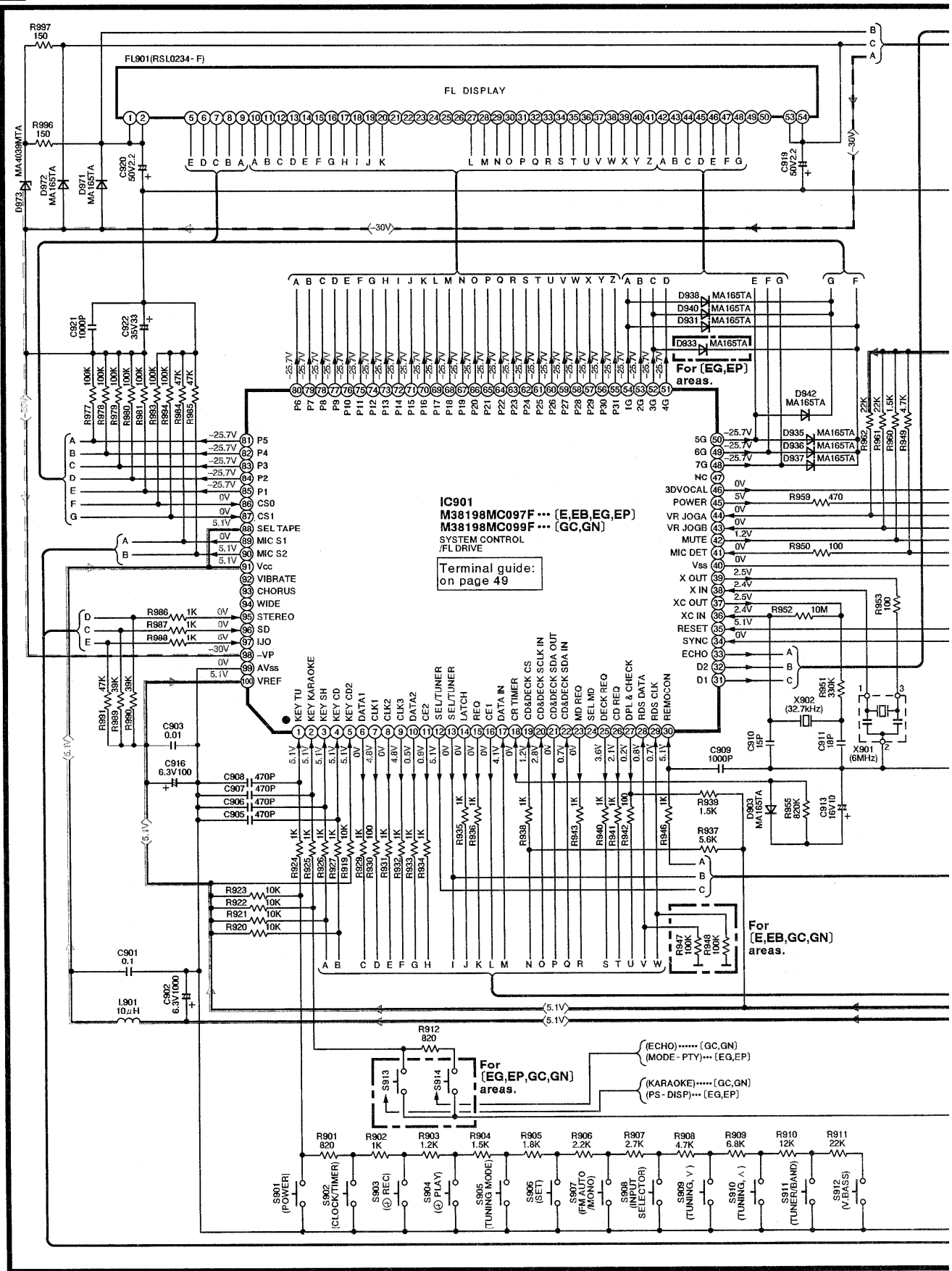

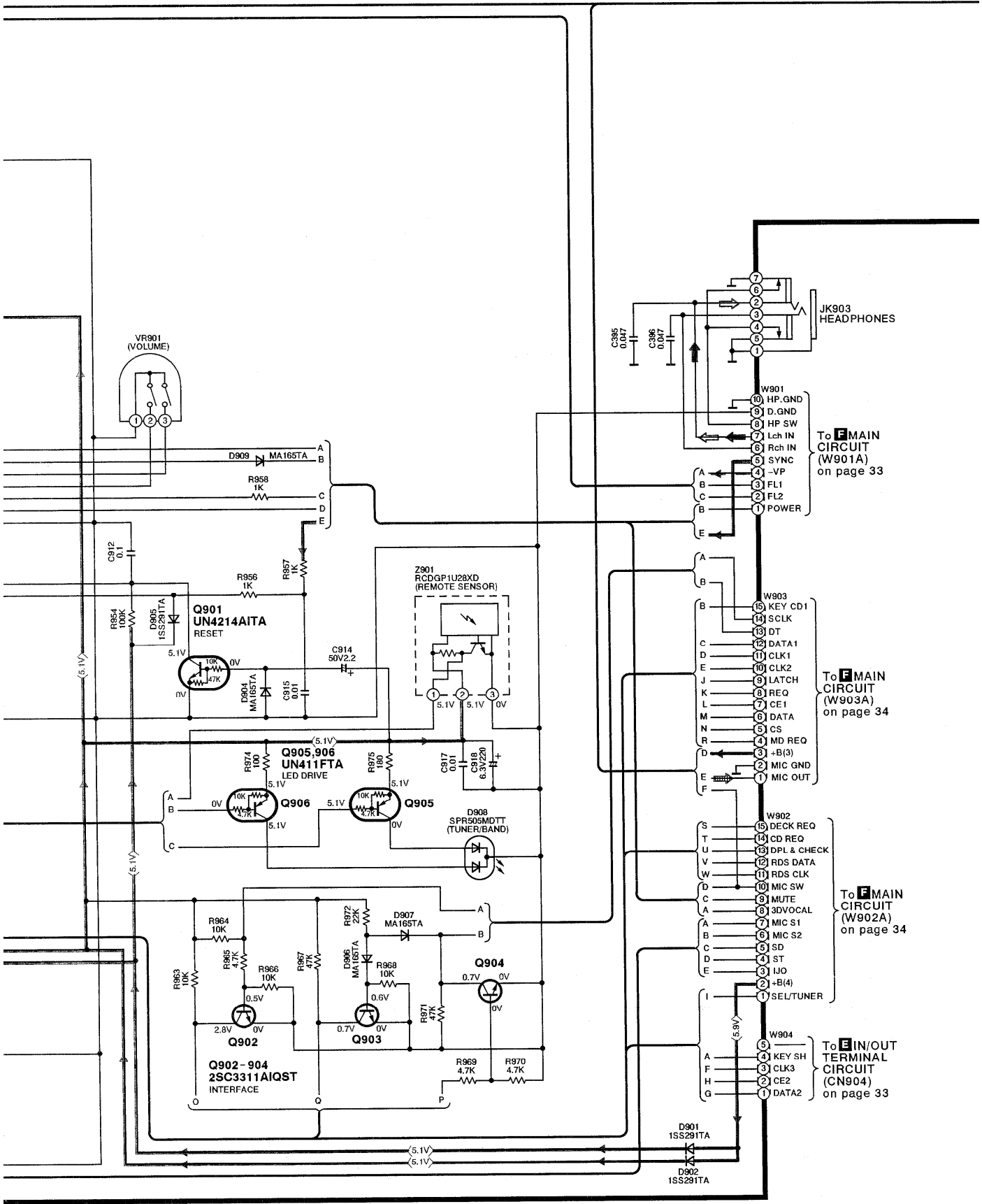
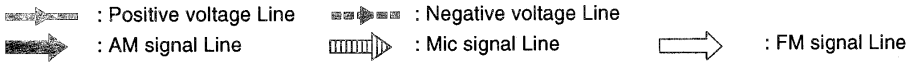

To MAIN CIRCUIT (W901A) on page 33

To MAIN CIRCUIT (W903A) on page 34

To MAIN CIRCUIT (W902A) on page 34

To IN/OUT TERMINAL CIRCUIT (CN904) on page 33

B OPERATION CIRCUIT (P.C.Board: on page 43)

C MIC JACK CIRCUIT (P.C.Board: on page 44)

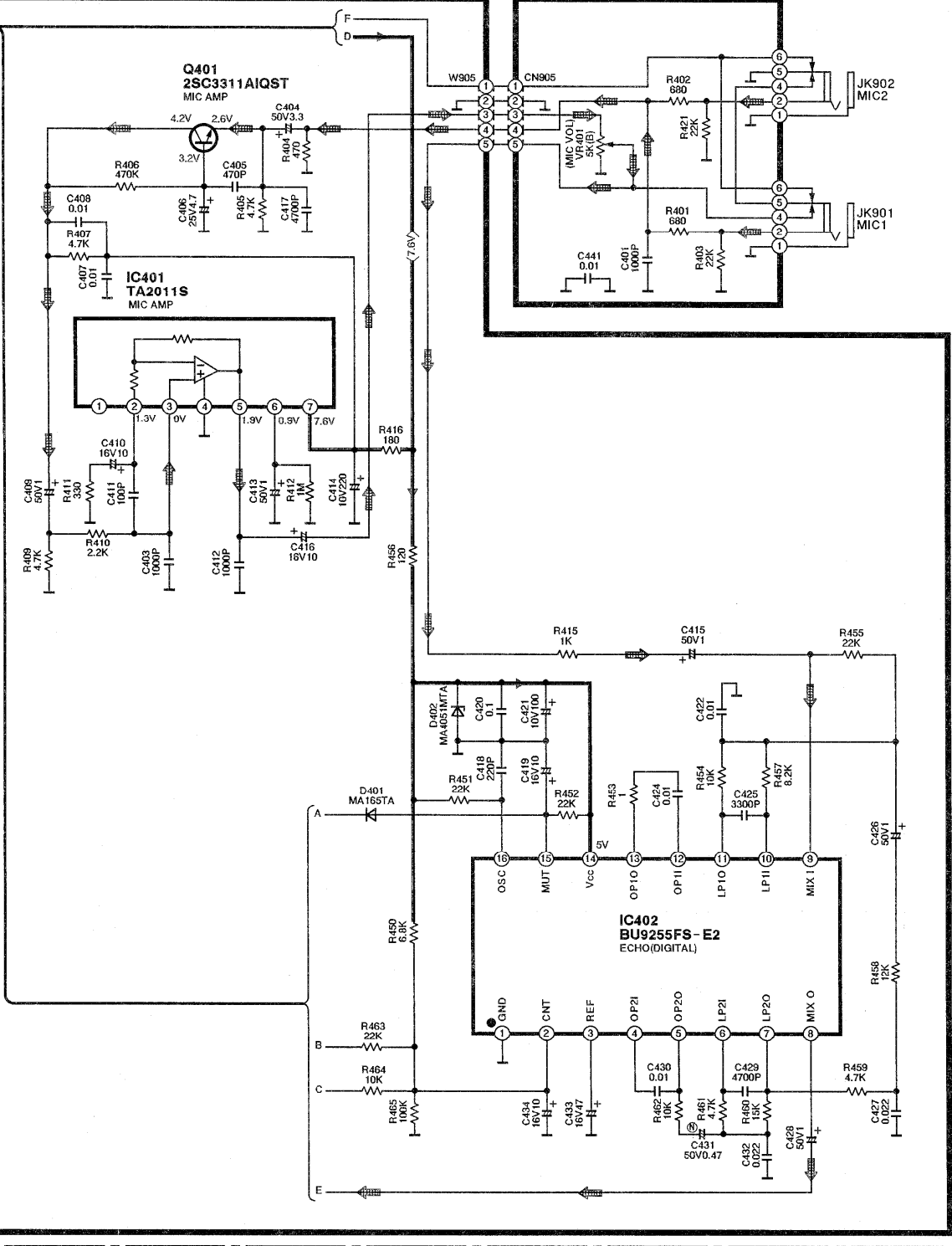

For [GC,GN] areas.

- : Positive voltage Line
- : Negative voltage Line
- : Surround Speaker signal Line
- : AM signal Line
- : FM signal Line
- : Mic signal Line
- : Center Speaker Drive signal Line

D DOLBY PROLOGIC CIRCUIT (P.C.Board: on page 44)

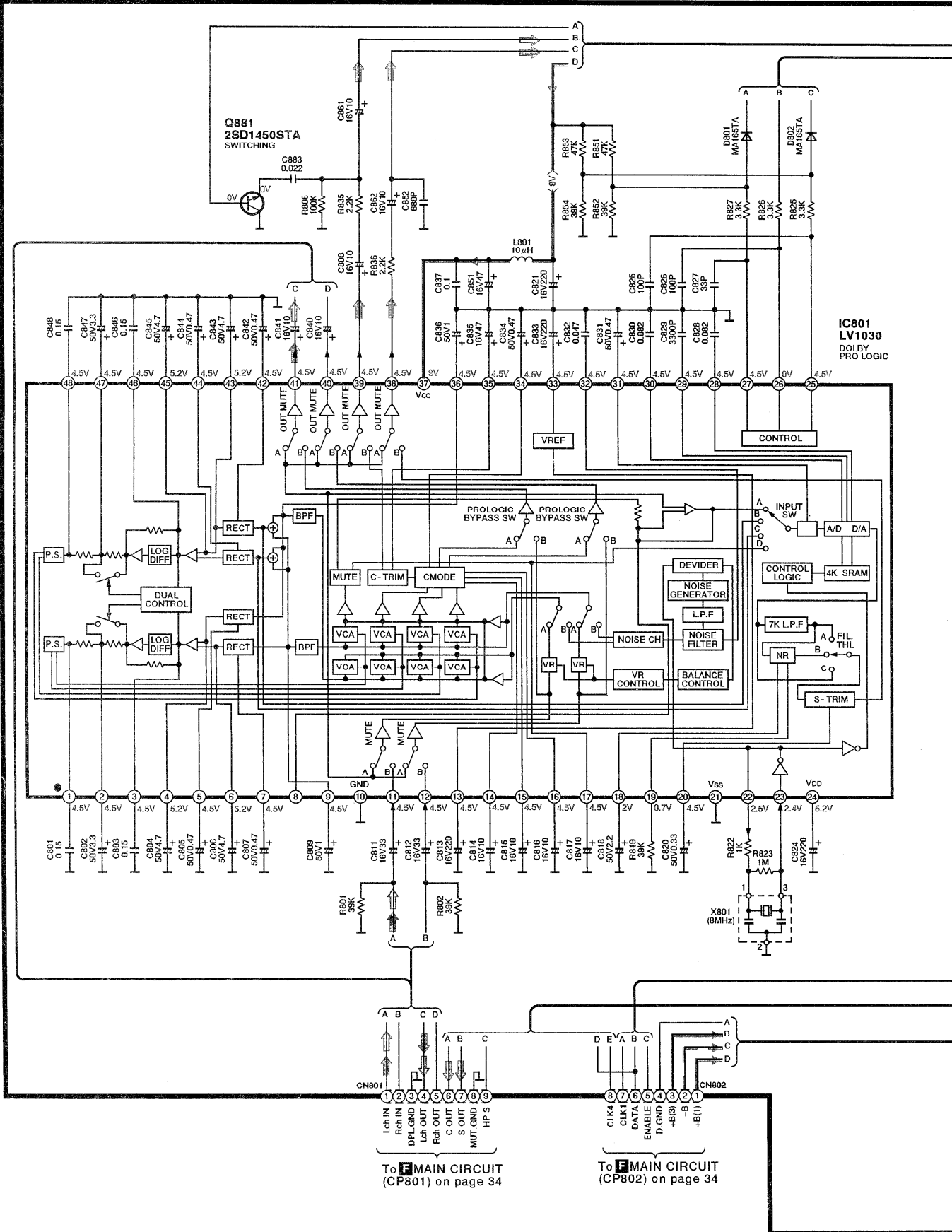

D DOLBY PROLOGIC CIRCUIT (P.C.Board: on page 44)

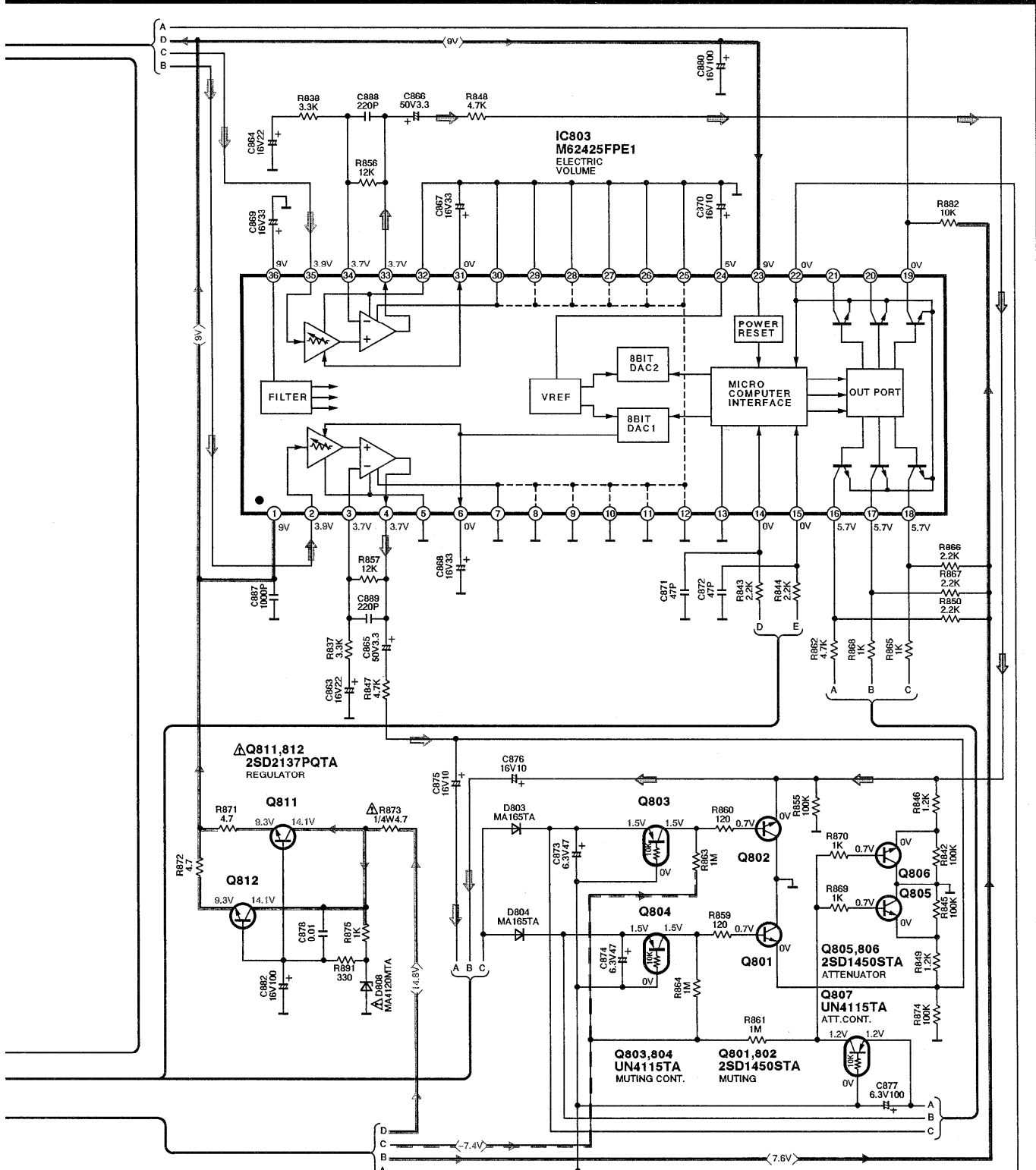

E IN/OUT TERMINAL CIRCUIT (P.C.Board: on page 44)

F MAIN CIRCUIT (P.C.Board: on pages 44,45)

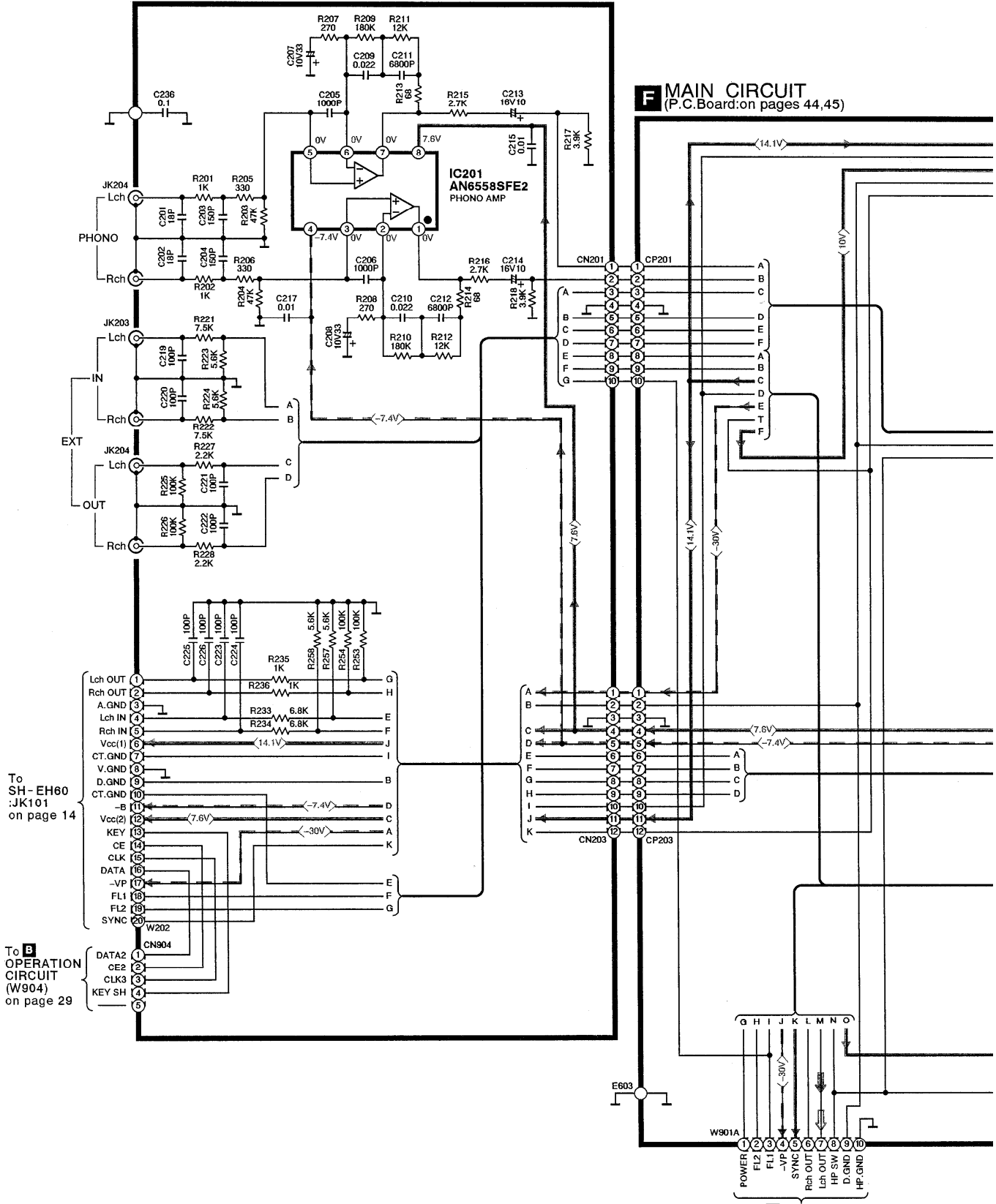

To SH-EH60 :JK101 on page 14

To OPERATION CIRCUIT (W904) on page 29

To OPERATION CIRCUIT (W901) on page 29



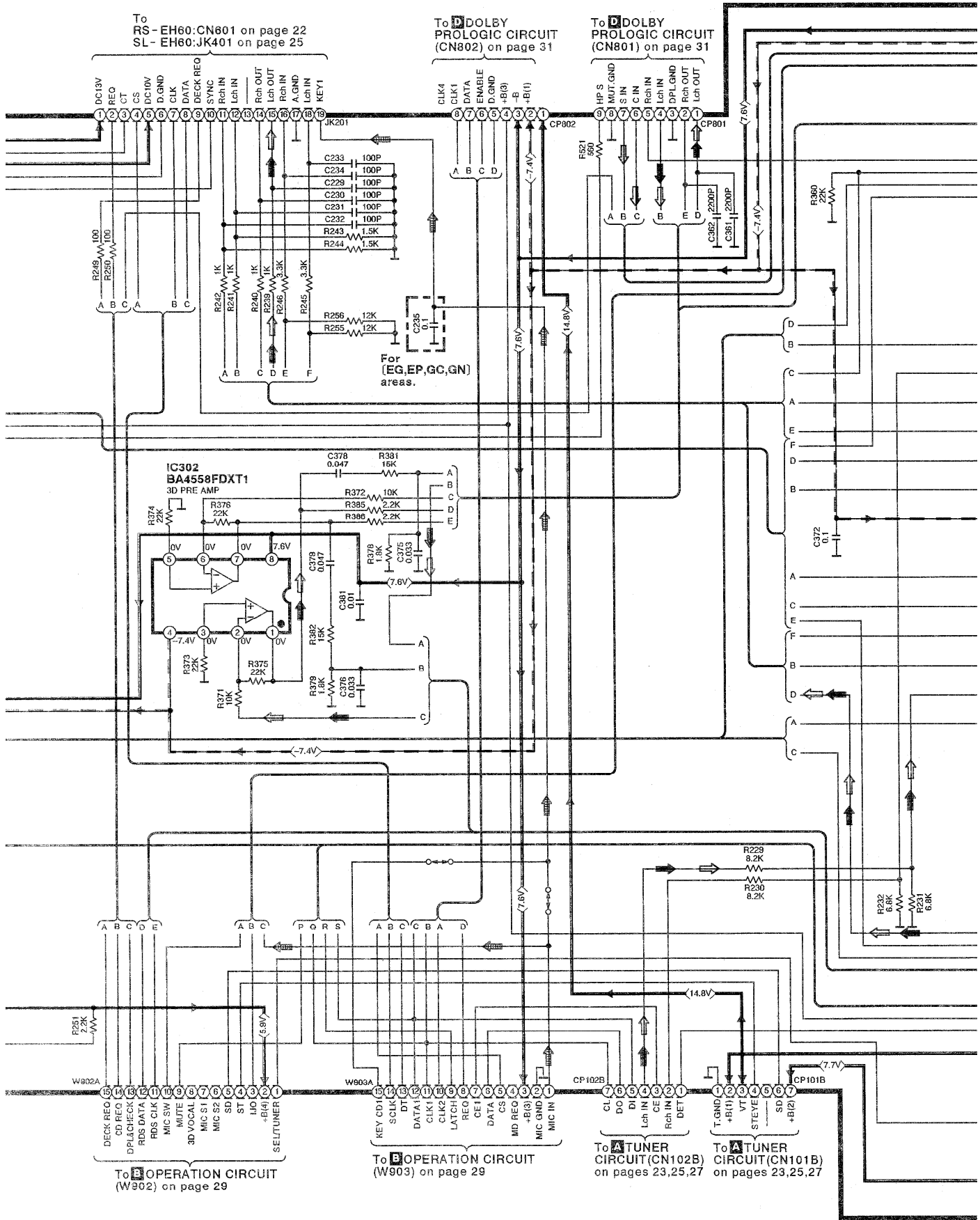
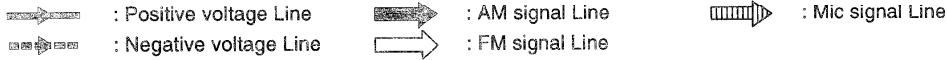



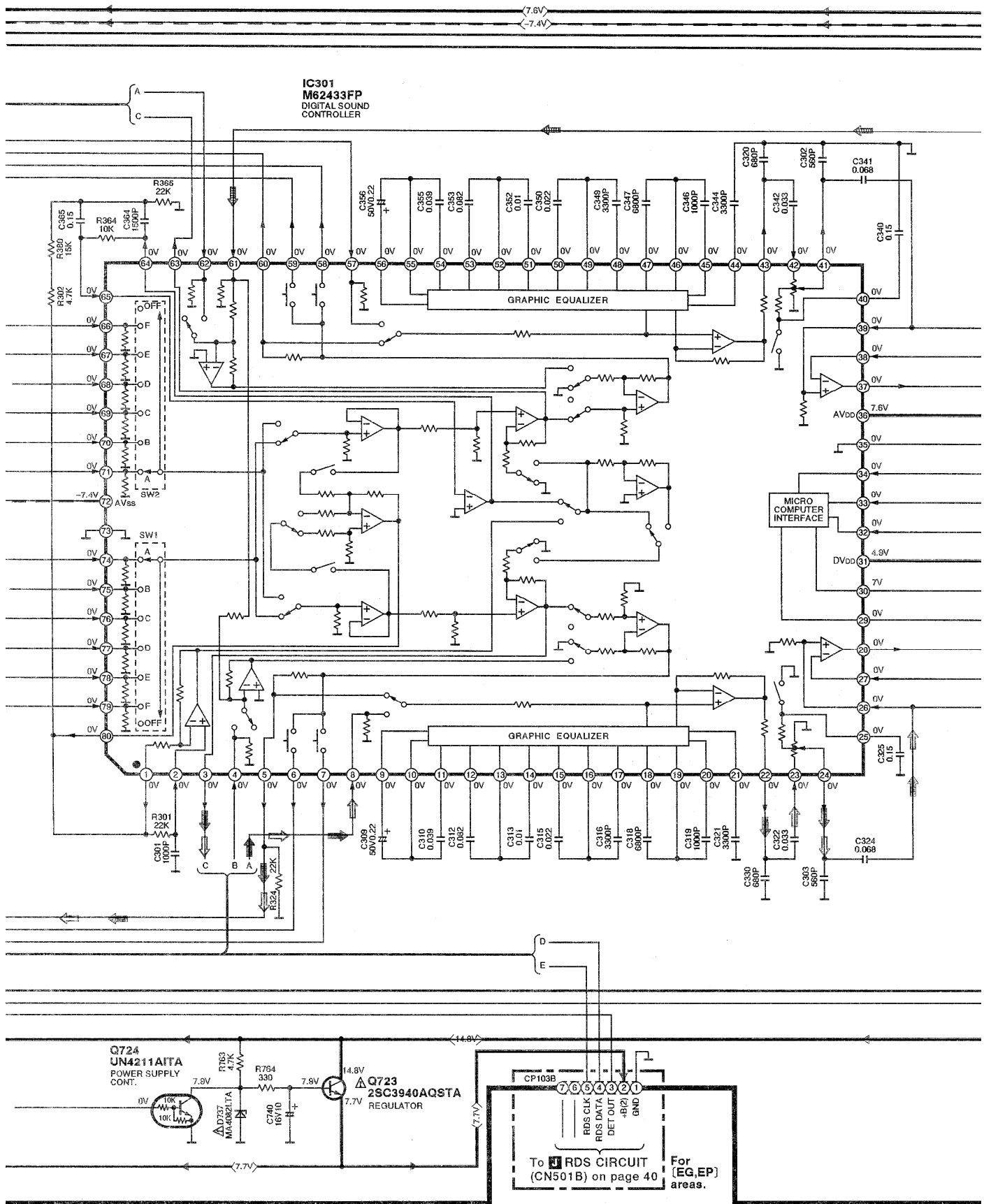

- : Positive voltage Line
- : Negative voltage Line
- : Surround Speaker signal Line
- : AM signal Line
- : FM signal Line
- : Mic signal Line
- : Center Speaker Drive signal Line



F MAIN CIRCUIT (P.C.Board: on pages 44,45)



SA-EH60

-  : Positive voltage Line
-  : Negative voltage Line
-  : Surround Speaker signal Line
-  : AM signal Line
-  : FM signal Line
-  : Center Speaker Drive signal Line
-  : Mic signal Line
-  : Center Speaker Drive signal Line

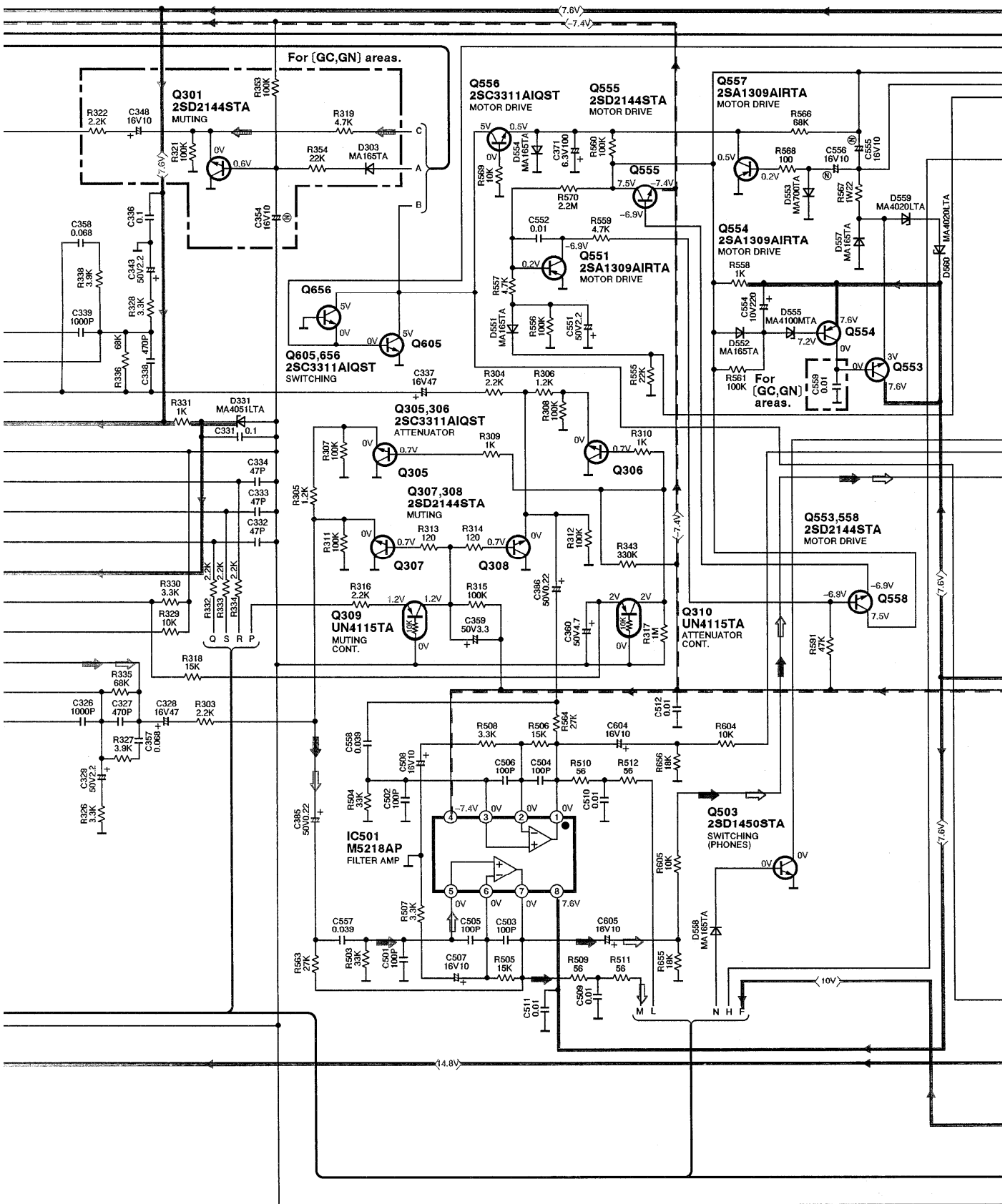

F MAIN CIRCUIT (P.C.Board: on pages 44,45)

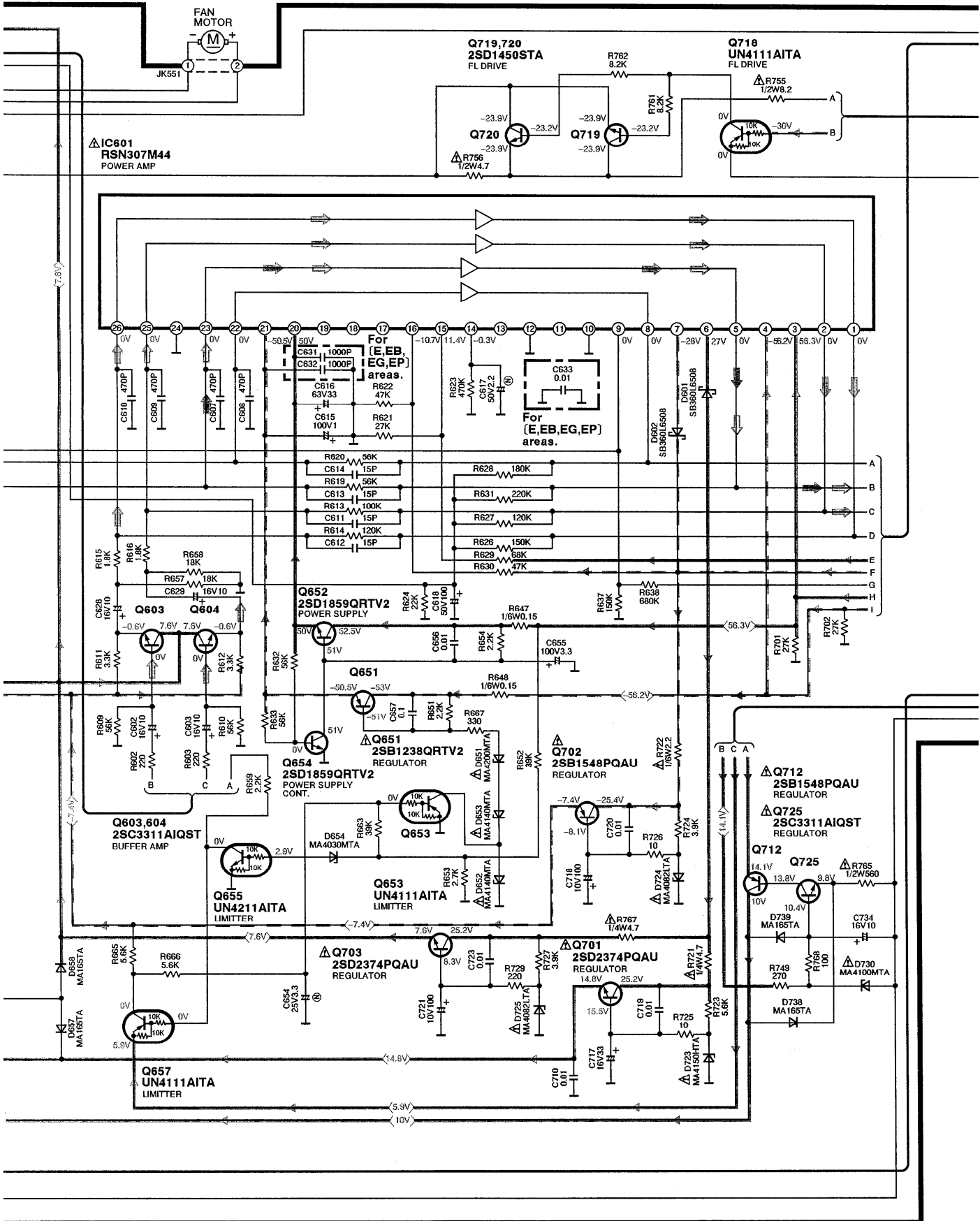

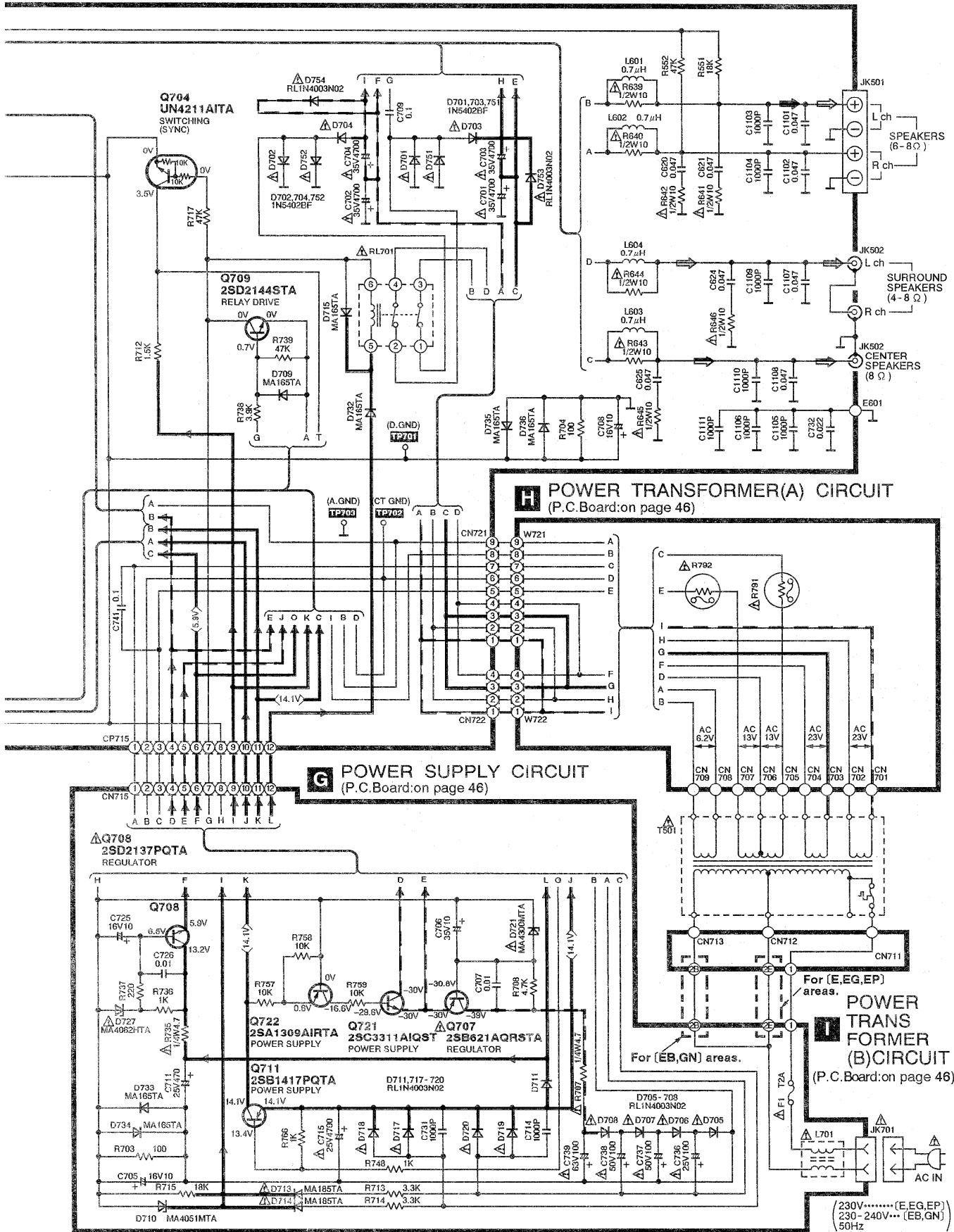

POWER SOURCE CIRCUIT For [GC] area.

H POWER TRANSFORMER(A) CIRCUIT
(P.C.Board: on page 47)

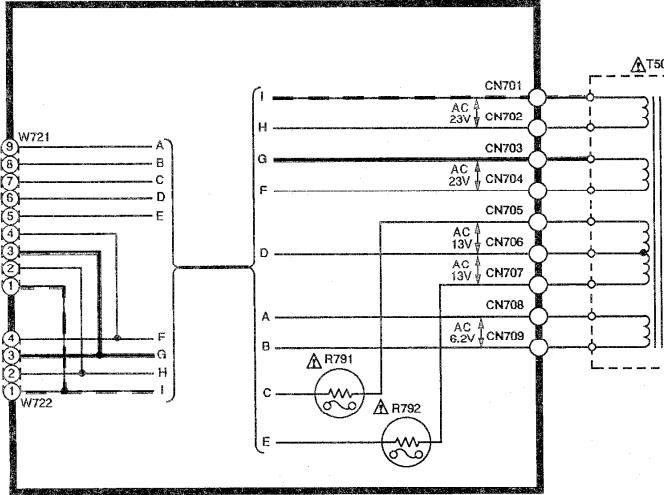

L POWER TRANSFORMER(B) CIRCUIT
(P.C.Board: on page 47)

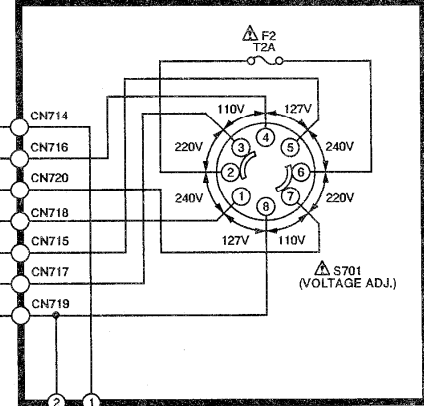

G POWER SUPPLY CIRCUIT
(P.C.Board: on page 47)

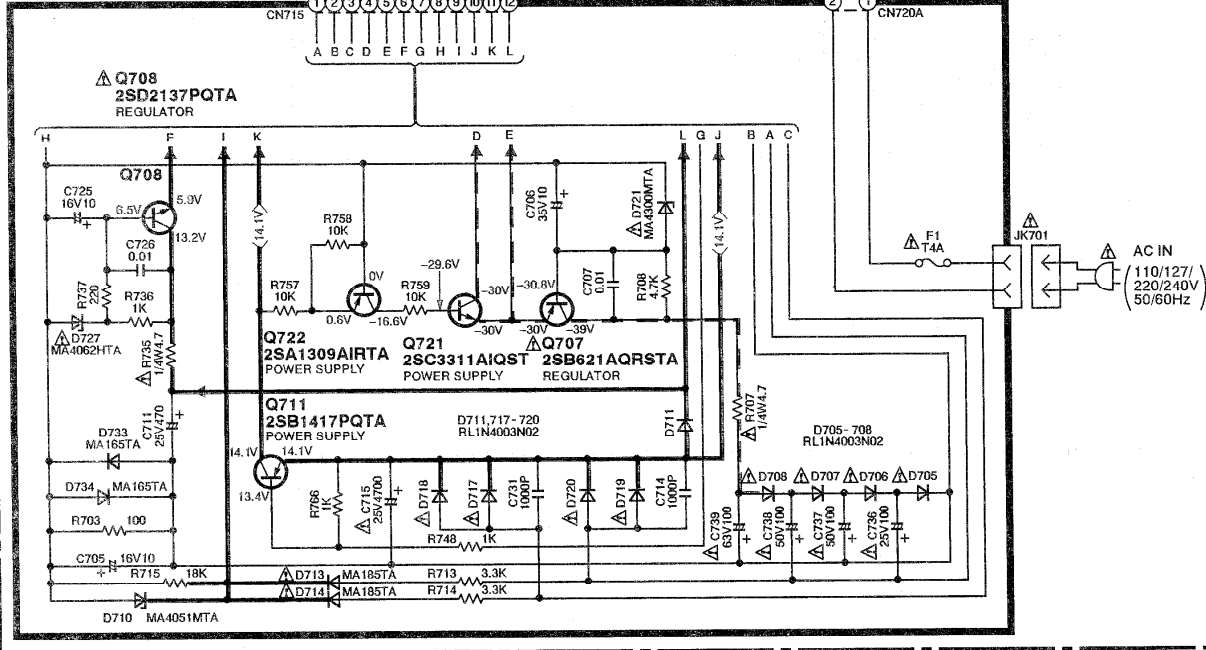

- : Positive voltage Line
- : Negative voltage Line
- : Surround Speaker signal Line
- : AM signal Line
- : FM signal Line
- : Mic signal Line
- : Center Speaker Drive signal Line

J RDS CIRCUIT For [EG,EP] areas. (P.C.Board: on page 46)

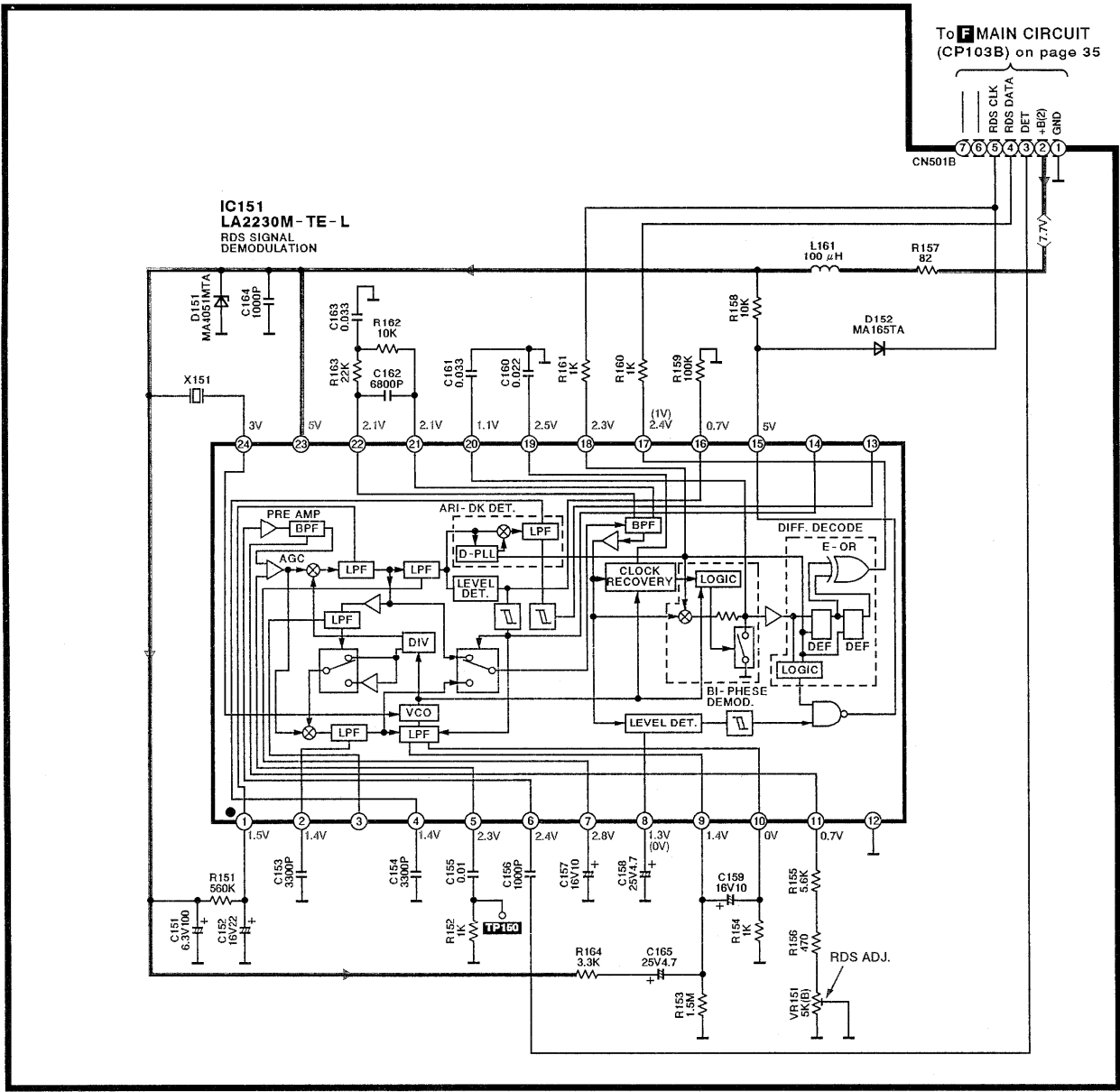

: Positive voltage Line